

B306 and B506 Remote Airborne Particle Counters

0.1 CFM (2.83 LPM)

- Industry's highest concentration of 15,000,000 particles/ft³ @ 10% coincidence loss
- Ideal for use in cleanrooms, industrial health and safety, and air quality applications
- >10 hours continuous operation on a fully charged battery
- Industry's first Sleep Mode and Power Conservation Mode with Intelligent Battery
- The most comprehensive internal self-diagnostics of any remote particle counter
- Internet of Things (IoT) communication allows for network or cloud-based data options



The Airy Technology® B306 and B506 Remote Particle Counters measure 0.3 or 0.5 to 25.0 µm with a flow rate of 0.1 CFM (2.83 LPM). Easy to configure, these instruments display up to 6 user-selectable size channels as well as (optional) temperature and relative humidity. View data or export to Instrument Management Software (IMS). Airy Technology® counters can be controlled and monitored remotely via web browser.

The B306 and B506 can be used as stand-alone battery operated instruments or they can be easily integrated into a building automation and cleanroom management system via Ethernet, USB, or (optional) Wireless 802.11 b/g, RS-485 or RS-232.

All Airy Technology® counters meet ISO 21501-4 and JIS B9921. The B306 and B506 ensure compliance with an on-board pulse height analyzer.

Features and Benefits

- B306: Measures 0.3 µm to 25 µm
- B506: Measures 0.5 µm to 25 µm
- 0.1 CFM (2.83 LPM) flow rate
- Long life laser diode technology
- Measures up to 6 channels of simultaneous data
- Large easy-to-use icon driven color touch screen display
- (Optional) temperature and relative humidity probe available
- Stores up to 45,000 sample records, 1,000 sample locations
- Easy configuration and transferable from instrument to instrument
- Connect using Ethernet, USB or (optional) Wireless 802.11 b/g, RS-485 or RS-232
- Static or dynamic IP address (DHCP)
- Remote diagnostics allows for remote service investigation through the Internet
- Internal audible alarm with comprehensive alarm management
- User-selectable channel sizes
- Complies with ISO 21501-4 and JIS B9921 standards
- Easy to clean and wipe down with minimal particle traps
- Seamless integration into a facility monitoring system
- Lightweight stainless steel enclosure
- 1 year limited warranty. Extended warranties available.

Specifications

Models	B306	B506
Size Range	0.3 to 25 µm	0.5 to 25 µm
Size Channels	Factory calibrated at 0.3, 0.5, 1.0, 2.5, 5.0, 10.0 µm Variable binning - user defined channel sizes	Factory calibrated at 0.5, 0.7, 1.0, 2.5, 5.0, 10.0 µm Variable binning - user defined channel sizes
Counting Efficiency	50% @ 0.3 µm; 100% for particles >0.45 µm per JIS	50% @ 0.5 µm; 100% for particles >0.75 µm per JIS
Flow rate	0.1 CFM (2.83 LPM)	
Concentration Limit	15,000,000 Particles/ft ³ @ 10% coincidence loss	
Battery Run Time	>10 hours continuous operation	
Light Source	Long life laser diode	
Zero Count	<1 count / 60 minutes (<1 particles / 6 ft ³)	
Count Alarms	1 to 9,999,999 counts	
Calibration	NIST traceable	
Display	4.3" (10.9 cm) WQVGA (480x272) color touch screen	
Printer	(Optional) External thermal printer available	
Vacuum Source	Internal pump with automatic flow control	
Filtered Exhaust	Internal HEPA filter	
Number of Channels	6	
Custom Size Channels	Calibration for custom size channels available	
Audible Alarm	Adjustable built-in alarm	
Battery	Removable Li-ion	
Battery Recharge Time	4 hours within instrument (<2 hours with external battery charger)	
Reports	ISO 14644-1, EU GMP Annex 1, FS 209E	
Communication Modes	Ethernet and USB. (Optional) Wireless 802.11 b/g, RS-485 or RS-232	
Environmental Sensor	Temp and RH probe 32° to 122°F (0° to 50°C) ±1°F (0.5°C), 15-90% ±2% relative humidity	
Alarm	Alarms on counts for all particle sizes, sensor failure, environmental sensors and flow	
Standards	ISO 21501-4 and JIS B9921	
Instrument Calibration	Recommended minimum once per year	
External Surface	Stainless steel	
Dimensions (L x W x H)	5.22" x 3.81" x 9.42" (14.0 cm x 9.7 cm x 23.9 cm) includes barb fittings	
Weight	2.6 lb (1.18 kg)	
Accessories	Operating manual and IMS Software on USB flash drive, isokinetic probe, purge filter, battery, USB cable, power supply and cable	
Optional Accessories	Printed manual, temperature relative humidity sensor, isokinetic probes, barb fittings, filter, data cable, sample tubing, IMS-RT monitoring system	
Buffer Memory	45,000 sample records (rotating buffer) including particle count data, environmental data, locations, and times. Scrollable on screen or printout.	
Sample Locations	Up to 1,000 locations 20 characters long	
Sample Time	1 second to 99 hours	
Power	110 to 240 VAC 50/60 Hz universal in-line power supply	
Operating Conditions	41° to 104°F (5° to 40°C) / 20% to 95% non-condensing	
Storage Conditions	32° to 122°F (0° to 50°C) / Up to 98% non-condensing	
Warranty	1 year limited warranty. Extended warranties available.	

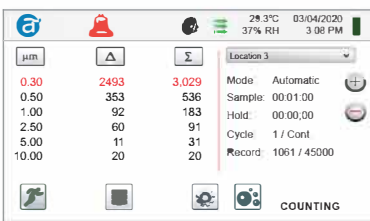

Audible and Visual Alarm Management



Icon Driven Menus for Ease-of-Use

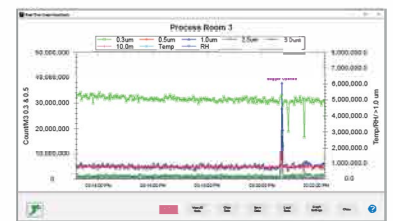

Control and Manage Remotely with IMS

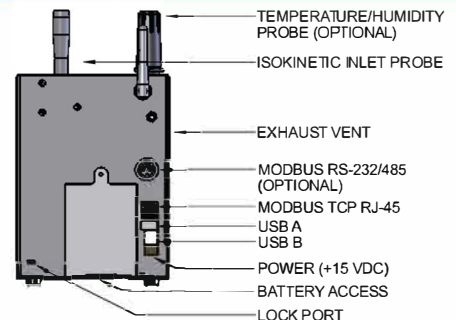
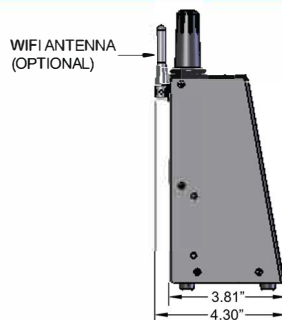
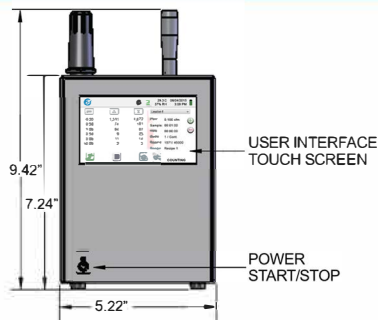

PAT. <https://particlepatents.com/> Additional Patents Pending.

Particles Plus, Inc. reserves the right to change specifications without notice. Contact hello@airytechnology.com or your local distributor for more details. Airy Technology and the Airy Technology logo are trademarks of Particles Plus, Inc. ©2020 Particles Plus, Inc. All rights reserved.

REV 20200601-B306-B506



31 Tosca Drive
Stoughton, MA 02072 U.S.A.
+1-781-341-6898
www.airytechnology.com